

**USER MANUAL**

**Si-CA 130  
GAS ANALYZER**



# Table of contents

<b>1. Safety instructions</b> .....	<b>5</b>
1.1 Warnings.....	5
1.2 Environment protection .....	5
1.3 Symbols used .....	5
<b>2. Introduction</b> .....	<b>6</b>
2.1 Analyzer description .....	6
2.2 Main features.....	7
2.3 Conformity and standards .....	9
2.3.1 FCC rules .....	9
2.3.2 Canadian standard .....	9
<b>3. First Start-up</b> .....	<b>10</b>
<b>4. Features</b> .....	<b>11</b>
4.1 General features.....	11
4.2 Dimensions .....	11
4.3 Parameter specifications .....	12
<b>5. Perform a flue gas analysis</b> .....	<b>13</b>
5.1 Prepare the instrument before the analysis.....	13
5.2 Perform a gas analysis .....	13
5.3 Turn ON and OFF the gas sampling pump .....	14
5.4 Visualize data as graph.....	14
5.5 Save the analysis.....	14
5.6 Print the analysis results .....	14
5.7 Use the Zoom function .....	15
<b>6. Set the general parameters of the analyzer</b> .....	<b>16</b>
6.1 Set the time .....	16
6.2 Set the time zone .....	16
6.3 Set the date .....	16
6.4 Set the language.....	16
6.5 Set the country.....	16
6.6 Set the autozero.....	16
6.7 Set the purge time.....	16
6.8 Set the self-extinction .....	17
6.9 Set the brightness of the screen.....	17
6.10 Reset to factory setting.....	17
<b>7. Set the parameters of the analysis</b> .....	<b>18</b>
7.1 Set the fuel .....	18
7.1.1 Select the fuel .....	18
7.1.2 Create a fuel .....	19
7.2 Set the CO pump cut-off level.....	19
7.3 Set the NOx factor .....	20
7.4 Set the Smoke/soot index .....	20
7.5 Set the alarms .....	20
7.6 Zero draft sensor .....	21
7.7 Set the atmospheric pressure .....	22
7.8 Set the air temperature.....	22
7.9 Set the display configuration.....	23
7.10 Set the stack cross-sectional area .....	23
<b>8. Set the measuring unit</b> .....	<b>24</b>
<b>9. Set the data saving</b> .....	<b>25</b>
<b>10. Set the printer</b> .....	<b>26</b>
10.1 Set the printer connection.....	26

10.2 Custom the printing header .....	26
10.3 Set the number of copies .....	26
<b>11. Analyzer information .....</b>	<b>27</b>
11.1 Service and Calibration .....	27
11.1.1 Calibration information .....	27
11.1.2 Service center contact .....	27
11.1.3 Perform calibration .....	27
11.2 Gas sensor information .....	28
11.3 Other information .....	28
<b>12. Perform other measurements .....</b>	<b>29</b>
12.1 Perform CO monitoring .....	29
12.2 Perform a gas tightness test .....	29
12.2.1 Perform a gas tightness test according to UNI 7129 (new piping) .....	29
12.2.2 Perform a gas tightness test according to UNI 11137 (existing piping) .....	29
12.3 Gas pump flow rate .....	31
12.4 Heat exchanger integrity test .....	31
12.5 Perform a Stack Gas Velocity measurement with a Pitot tube .....	31
12.6 Perform a draft measurement .....	32
12.6.1 Perform a draft measurement with the flue gas probe .....	32
12.6.2 Perform a draft measurement with the draft probe .....	32
12.7 Perform a measurement of smoke/opacity .....	32
12.7.1 Perform the measurement .....	32
12.8 UK test .....	32
12.8.1 CO sweep .....	33
12.8.2 Room Safety .....	33
12.8.3 Let By .....	34
<b>13. Maintenance of the analyzer .....</b>	<b>36</b>
13.1 Life-time of the sensors .....	36
13.2 Replaced used sensor .....	36
13.3 Replace filter inside the water trap .....	37
13.4 Cleaning the analyzer .....	37
<b>14. Optional accessories .....</b>	<b>38</b>
<b>15. Spare parts .....</b>	<b>39</b>

# 1. Safety instructions

Before using the device, please read carefully this user manual. It delivers important information about the device operations, maintenance and storage.

## 1.1 Warnings

- Interior or exterior use.
- Do not expose the probe tip to an open flame.
- Control device sealing with the probe.
- Respect the range of the device measurement (0 to 60 bar)
- After measurement and before clearing the device and accessories, wait for the probe to cool down. A hot probe can cause burns.
- Condensate contain a low level of acidity, do not touch directly the condensate. Make sure no condensate is leaking into the device.
- This device has been developed for the measurement of flue gas parameters. It must not be used in any other purpose.
- This device has been developed, produced and sold exclusively to trained and qualified experts in the field of HVACR and combustion emissions monitoring. Appropriate training might be necessary in order to guarantee a riskless use of this instrument. Sauermann is not responsible for any possible accident during its use.
- Please always use the device in accordance with its intended use and within parameters described in the technical features in order not to compromise the protection ensured by the device.
- When using the device, the safety of the system integrating the device is the responsibility of the system assembler.
- This device can pose a risk for wearers of pacemakers. Respect a distance of at least 10 cm (4") between the device and the wearer.
- Respect a safety distance with other electronic apparel like computers, credit cards, computers or TV screens which could be damaged by the magnetic field of the apparel.
- Only the accessories provided with the device or available as an option must be used.
- Do not use the device if it is damaged or if it operates abnormally. Inspect the device before every use. In case of doubt, please contact Sauermann's After-sales service.
- Do not authorize pressures beyond the device limits. Please refer to the technical features described in this user manual.
- The device must not be exposed to rain or any other humid environments (> 85 %RH).
- Do not use the device next to explosive and corrosives gases, vapour or dust.
- Do not place your fingers in movable zones of the device (articulations).
- The device must not be used in ATEX zones according to applicable standards.
- Do not store the device with solvents. Do not use desiccants. Do not use isopropanol.
- Do not obstruct the ventilation outflows of the device.
- During use, keep inspecting the device and accessories for effective operation and your own safety.
- Do not give this product to a child.
- If the device falls or in case of similar inconveniences, or if an irregular malfunction appears, please send back the device to Sauermann After-sales service for a technical check and to ensure your own safety.

## 1.2 Environment protection

Send back the device at its end of working life to a waste collection center for electrical and electronic components (according to local regulations), or send it back to Sauermann to ensure a required waste collection in the respect of the environment.

## 1.3 Symbols used

For your safety and in order to avoid any damage of the device, please follow the procedure described in this user manual and read carefully the notes preceded by the following symbol:



The following symbol will also be used in this user manual:  
Please read carefully the information notes indicated after this symbol.



### 2.1 Analyzer description

The Si-CA 130 is a flue gas analyzer for emissions monitoring of boiler, engine, & other combustion applications with between two and three interchangeable gas sensors. Its main features are the following :

- Gas sensor options include O<sub>2</sub>, CO, NO, Low NO, NO<sub>x</sub>, Low NO<sub>x</sub>
- CO measurement up to 8 000 ppm
- NO<sub>x</sub> capable with NO sensor (optional)
- Large Color touch screen
- Field Replaceable Pre-Calibrated Sensors
- Mobile phone App for remote display and control



**This gas analyzer is designed to measure parameters of flue gas in exhaust stream of combustion equipment. It can not be used in a permanently way and/or used as an alarm system.**



1. Probe handle
2. Positioning cone (Adjustable)
3. Flue gas probe
4. Large color touch screen
5. On/off button



1. Min-DIN connection for optional CO and CO<sub>2</sub> ambient air probes
2. Thermocouple connection for air temperature
3. Thermocouple connection for flue gas temperature
4. P- connection
5. P+ connection
6. Gas connection (Coming from water trap)
7. USB C connection

## 2.2 Main features

- **Screen**

Color touch screen, 10.9 cm (4.3"), 480 x 272 pixels with backlit. It allows to display measured parameters in a more comfortable format for the operator. Thanks to the zoom function, you can view on the screen the measured values in increased or decreased characters.

- **Battery charger**

The instrument is supplied with a 5 V, 2 A power adapter to charge the internal batteries. The current loading is indicated by a battery symbol on the top right of the screen. To ensure a complete charge, the battery charging time is 6.5 hours. The voltage of the power supply is 100-240 VAC, 50/60 Hz. The USB cable included with the analyzer connects the power supply to the device.

**Information about the low battery and power charging:**

- When the battery of the analyzer is too low, the analyzer will make a purge before turning off.
- When the analyzer is turned off and connected to USB or to the power supply, screen of the analyzer displays: "Device charging".
- If the analyzer is turned on and connected to USB or to the power supply, the power charging icon  will be displayed on the top of the screen.

- **Flue gas suction pump**

The pump, inside the gas analyser, is a diaphragm pump with a motor. It is energized in direct current directly by the instrument in a way to get an optimal suction of flue gases.

- **Flue gas probe**

Probe in stainless steel with a handle in plastic, with a standard length of 30 cm (12") and with an adjustable positioning cone to maintain the contact tip inside the duct. The probe is connected to the instrument by 3 m (10') of dual hose. Other probe lengths (75 cm, 1 m and 1.5 m) are available as options.

- **Interchangeable measurement sensors**

The analyzer uses electrochemical sensors to measure the oxygen, the carbon monoxide and carbon dioxide. Measurement sensors (including NO, Low NO, NO<sub>x</sub> and low NO<sub>x</sub>) are interchangeable. Regularly recharge the battery to guarantee an optimal operating of the electrochemical sensors. It is absolutely necessary to avoid falling to 0% battery as this would irreversibly damage the cells.

- **Temperature sensors**

Flue gas temperature is measured with a thermocouple integrated in the contact tip. The connection to the analyzer is made thanks to a single male type K thermocouple (nickel-nickel chromium) connector for measurements up to 1250 °C (2282 °F).

The instrument has a NTC thermoresistance sensor for the measurement of internal temperature; this sensor is also used for the measurement of ambient temperature.

If a temperature control of the combustive air must be performed directly by the supply duct (e.g. room sealed boiler), a Tck temperature probe can be used. It is recommended to perform this measurement to make the efficiency calculation of the installation more precise.

- **Pressure sensors**

The standard semiconductor type pressure sensor can measure draft and differential pressure ( $\Delta P$ ) for a range of  $\pm 200$  mbar ( $\pm 80$  in WC). An optional high accuracy pressure measurement can be added for a range of  $\pm 500$  Pa.

- **Supply input of flue gases and +/- pressure**

There are two hose connections coming from the probe that connect to the bottom of the analyzer. One comes from the water trap assembly and connects to the gas inlet (labelled "G" and colored black) while the other connects to the high pressure inlet (labelled "P+" and colored orange).

- **Fuel types**

The analyzer is supplied with technical data which characterizes the most common fuels. It is also possible to add user defined fuels and their corresponding coefficients if needed.

- **Calibration certificate**

The analyzer is calibrated by comparison with standard of metrology laboratories, which are periodically certified closed to laboratories known at the international level. Each analyzer is supplied with its calibration certificate in which, for each measured parameter, are indicated the nominal value, the one measured, the admitted error limits and the found error. It is advised to calibrate the instrument at least once a year.

- **Water trap**

The analyzer has an external water trap assembly that hangs directly below the analyzer. The flue gas is cooled and dried in the lower chamber. Accumulated condensate must be manually drained as needed. The upper chamber has a filter cartridge to remove dust and particulates from the flue gas. The filter should be replaced periodically as needed.



**THE WATER TRAP MUST BE IN VERTICAL POSITION AT ALL TIMES DURING OPERATIONS FOR OPTIMAL PERFORMANCE!**

**The water trap must be emptied before storing it in the transport case.**

- **Measured and calculated values**

The following parameters are displayed according to your analyzer model:

- **O<sub>2</sub>**: Direct O<sub>2</sub> sensor measurement (also for Heat Exchanger Test)
- **CO**: Direct CO sensor measurement (also for Heat Exchanger Test)
- **NO**: Direct NO sensor measurement
- **NO L**: Direct Low NO sensor measurement
- **NOx**: Calculated NOx value
- **NOx L**: Calculated Low NOx value with NOx factor
- **CO<sub>2</sub>**: Calculated CO<sub>2</sub>
- **Eff. (η)**: Net Combustion Efficiency
- **Eff. (η+)**: Gross Combustion Efficiency
- **Loss (Q)**: Stack Heat Losses (net)
- **Loss (Q+)**: Stack Heat Losses (gross)
- **CE (ηc)**: Condensation efficiency calculated acc. to the UNI 10389-1 standard
- **X Air**: Calculated excess air
- **Lambda**: Calculated lambda value (for air to fuel ratio)
- **Air Ind (n)**: Calculated air index
- **PI**: Calculated CO to CO<sub>2</sub> Ratio, also called poison index
- **ΔP**: Differential pressure (also for Gas Tightness Test)
- **Draft**: Draft (static pressure) measurement
- **T flue**: Flue gas temperature
- **T air**: Air temperature
- **ΔT**: Differential temperature
- **T dp**: Calculated dew point temperature
- **CO AF**: Calculated CO Air Free = CO corrected for 0.0% O<sub>2</sub> Ref. level
- **COcorr**: Calculated value for Corrected CO = Lambda x Measured CO
- **CO Amb**: Ambient CO measurement using external probe
- **CO<sub>2</sub> Amb**: Ambient CO<sub>2</sub> measurement using external probe
- **Velocity**: Calculated Stack Gas Velocity
- **K Value**: Constant value used for velocity calculation
- **Volumetric Flow Rate**: Calculated Stack Gas Volumetric Flow Rate
- **Mass Flow Rate**: Calculated Stack Gas Mass Flow Rate
- **CO Monitor (Current & Max)**: CO measurement for room safety
- **Pump Flow Rate**: Measured flow rate of flue gas through the analyzer
- **ΔO<sub>2</sub>**: O<sub>2</sub> Variance during Heat Exchanger Integrity Test



- **ΔCO:** CO Variance during Heat Exchanger Integrity Test
- **Stack Cross Sectional Area:** Input for Stack Cross Sectional Area
- **O<sub>2</sub> Reference:** Input for O<sub>2</sub> Reference Level
- **NO<sub>x</sub> Factor:** Input for Assumed NO to NO<sub>2</sub> Ratio
- **Smoke/Soot:** Smoke index value
- **Atmospheric Pressure:** Input for Atmospheric Pressure



### Displaying of measurements:

When a value is out of range or unavailable, "---" will be displayed on the screen.

## 2.3 Conformity and standards

The analyser complies with 2014/53/EU (RED) and 2015/863 EU (RoHS 3). Document available on request. Moreover, the analyser complies with EN 50379-1 and EN 50379-2, UNI 7129; UNI 11137, UNI 10389, UNI 10845, UL & cUL Certification, BS 7967:2015, BS EN 50543:2011, UNE 60670-10 and ES.02173.ES

The analyzer was tested in accordance with the requirements of VDI 4206 - TÜV RgG 324 part 1.

Hereby, Sauermann Industrie SAS declares that the radio equipment type Si-CA 130 is in compliance with Directive 2014/53/EU. The full text of the EU declaration of conformity is available at the following internet address:

[sauermanngroup.com](http://sauermanngroup.com)

### 2.3.1 FCC rules

This equipment has been tested and found to comply with the limits for a Class B digital device, pursuant to part 15 of the FCC Rules. These limits are designed to provide reasonable protection against harmful interference in a residential installation. This equipment generates, uses and can radiate radio frequency energy and, if not installed and used in accordance with the instructions, may cause harmful interference to radio communications. However, there is no guarantee that interference will not occur in a particular installation. If this equipment does cause harmful interference to radio or television reception, which can be determined by turning the equipment off and on, the user is encouraged to try to correct the interference's by one or more of the following measures:

- Reorient or relocate the receiving antenna.
- Increase the separation between the equipment and receiver.
- Connect the equipment into an outlet on a circuit different from that to which the receiver is connected
- Consult the dealer or an experienced radio/TV technician for help.

Changes or modifications not expressly approved by Sauermann could voice the user's authority to operate the equipment. This device complies with part 15 of the FCC Rules.

Operation is subject to the following two conditions:

1. This device may not cause interference, and
2. This device must accept any interference received, including interference that may cause undesired operation.

### 2.3.2 Canadian standard

This device contains licence-exempt transmitter(s)/receiver(s) that comply with innovation, Science and Economic Development Canada's licence-exempt RSS(s). Operation is subject to the following two conditions:

1. This device may not cause interference
2. This device must accept any interference, including interference that may cause undesired operation of the device.

### 3. First Start-up

When the analyzer is first started up, parameters of the analyzer must be set. Keep  pressed for 3 seconds to turn ON the analyzer.



DO NOT insert the gas probe in the flue/chimney/stack at this time.



Tap "Start".

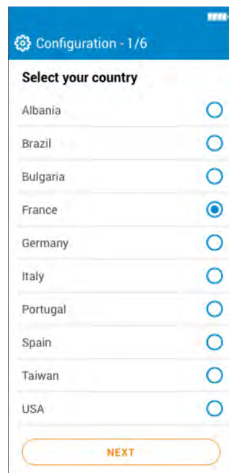

Select your country then tap "Next".

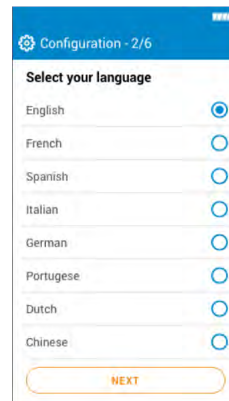

Select your language then tap "Next".

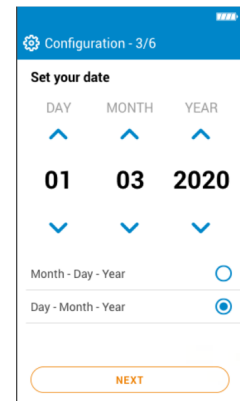

Set the date then tap "Next".

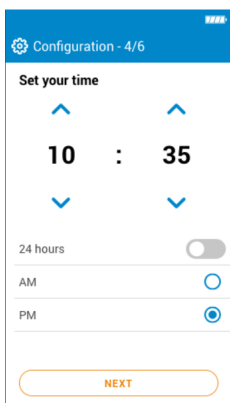

Set the time then tap "Next".

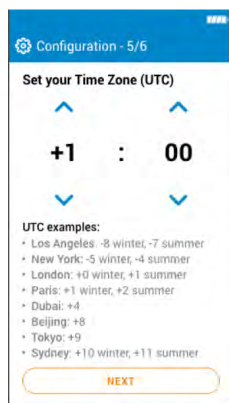

Set your time zone then tap "Next".

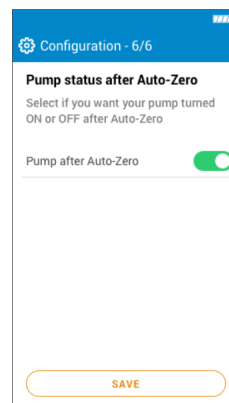

Select if you want your pump turned ON or OFF after Auto-Zero then tap "Save".

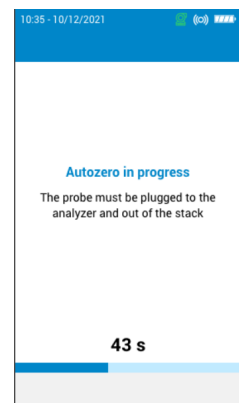

Autozero is in progress.



The probe can be inserted in the chimney. The analyzer displays the measurements.



The settings done during the first start-up can be reselected at a later time using the Settings menu.

## 4.1 General features

Dimensions	19.4 x 9.9 x 4.9 cm (7.5 x 3.5 x 4.9")
Weight	350 g (12 oz)
Display	Color Touch Screen with Graphing; Size: 480 x 272 pixels
Keypad	1 On-Off key
Material	ABS-PC
Protection	IP42
Connection	- Wireless: class 2 range, range frequency from 2402 MHz to 2480 MHz with a transmit power of 1 dBm. Range up to 15 m (50 ft), depending on smartphone radio strength. Minimum required versions: Android 8.0, iOS 12.4, BLE 4.0 Low Energy - USB
Power supply	Rechargeable battery, USB power supply Li-Ion 5100 mA/h 3.6 V battery / Power supply voltage of the mains unit: 100-240 Vac, 50-60 Hz Mains unit: 5 Vdc/2A
Battery	Battery life > 8 h; Charging time: Fully charge: < 6.5 h; 50%: < 2.5 h
Environmental conditions of use	Temperature: from -5 to 45 °C (23 to 113 °F), Hygrometry: in non-condensing conditions (< 85% RH) Maximum altitude: 2000 m (6561')
Storage temperature	From -20 to 50 °C (-4 to 122 °F)
Languages	English, French, German, Spanish, Italian, Portuguese, Chinese
European Union Directives	2014/53/EU (RED); 2015/863 EU (RoHS 3)
Regulations	EN 50379-1 and EN 50379-2; UNI 7129; UNI 11137; UNI 10389; UNI 10845; UL & cUL Certification; BS 7967:2015; BS EN 50543:2011; UNE 60670-10; ES.02173.ES TÜV SÜD Certification

## 4.2 Dimensions

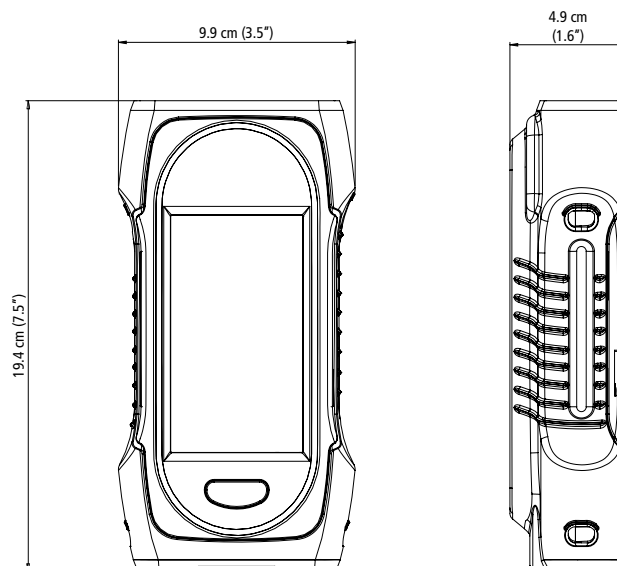

### 4.3 Parameter specifications

Parameter	Sensor	Measuring range	Resolution	Accuracy <sup>(1)</sup>	T <sub>90</sub> response time
O <sub>2</sub>	Electrochemical	0 to 25%	0.01%	±0.2% vol	< 30 s
CO	Electrochemical	0 to 8000 ppm	1 ppm	±8 ppm < 160 ppm ±5% rdg up to 2000 ppm ±10% rdg > 2000 ppm	< 40 s
	Probe	0 to 500 ppm	1 ppm	-	-
CO <sub>2</sub>	Calculated	0 to 99.9%	0.1%	-	-
	Probe	0 to 5000 ppm	1 ppm	-	-
NO (optional)	Electrochemical	0 to 5000 ppm	1 ppm	±5 ppm < 100 ppm ±5% rdg > 100 ppm	< 40 s
Low NO	Electrochemical	0 to 300 ppm	0.1 ppm	±1.5 ppm < 30 ppm ±5 % rdg > 30 ppm	< 40 s
NOx (optional)	Calculated	0 to 7500 ppm	1 ppm	-	-
Low NOx	Calculated	0 to 450 ppm	0.1 ppm	-	-
Flue temperature	TcK	-20 to +1250 °C -4 to +2282 °F	0.1 °C 0.1 °F	±2 °C or ±0.5% rdg <sup>(2)</sup> ±3.6 °F or ±0.5% rdg <sup>(2)</sup>	-
Air temperature	NTC or TcK	-20 to +120 °C -4 to +248 °F	0.1 °C 0.1 °F	±2 °C ±3.6 °F	-
	Pt100	-40 to 250 °C -40 to 482 °F	0.1 °C 0.1 °F	±(0.3% rdg ±0.25) °C -40°F to 32 °F: ±(-0.3% rdg +0.6) °F 32°F to 482 °F: ±(0.3% rdg +0.4) °F	-
Differential temperature	Calculated	0 to 1250 °C 0 to 2282 °F	0.1 °C 0.1 °F	-	-
Pressure/Draft	Semiconductor	-200 to +200 mbar -80 to +80 inH <sub>2</sub> O	0.01 mbar 0.001 inH <sub>2</sub> O	±1% rdg ±0.03 mbar ±1% rdg ±0.012 inH <sub>2</sub> O	-
High accuracy draft	Semiconductor	500 Pa	0.1 Pa	±0.5 Pa < 10 Pa ±3 Pa up to 150 Pa ±2 % rdg > 150 Pa	-
Excess air	Calculated	0 to 999%	1%	-	-
Efficiency	Calculated	0 to 100% (Gross/ HHV <sup>(3)</sup> )	0.1%	-	-
Efficiency (condensation)	Calculated	0 to 125% (Net/LHV <sup>(4)</sup> )	0.1%	-	-
Stack Gas velocity	Calculated	0 to 99 m/s 0 to 19,500 fpm	0.1 m/s 1 fpm	-	-

## 5. Perform a flue gas analysis

### 5.1 Prepare the instrument before the analysis



During the measurement, the analyzer must be in vertical position to keep the water trap vertical. Do not hold the analyzer in inclined or horizontal position.



Before the 1<sup>st</sup> use of the analyzer, a full charge of the battery should be made for 12 hours. Do not leave the battery completely discharged.



Empty the water trap if any condensate is inside it and after every use before you store it. For this operation the instrument has to be turned OFF.



In case of any default or damage of the instrument, Sauermann After-sales service shall be contacted. On the back of the analyzer, there is a label with the analyzer serial number. This number shall be communicated for every operation (technical operation or request of spare parts). This number is also available in "Analyzer information" menu (see page 27).

### 5.2 Perform a gas analysis

- Connect the flue gas probe to the analyzer. (Two hoses + thermocouple)
- Turn ON the instrument.
- Wait for the end of the autozero cycle (probe out of stack).

Gas analysis screen is displayed.

- Insert the probe in the flue/stack as suggested on the figure.

- Tap Menu icon

The screen with the different possible item menu is displayed.

- Tap "Gas analysis".

The screen displays the measured and calculated values.

- Tap the combustible fuel currently used on the top of the screen

The list of available fuels is displayed .

- Select the required combustible fuel and return to the Gas Analysis screen.

The screen displays values of the different parameters of the analysis.

- Perform measurement for at least 3 minutes until measurements stabilize.

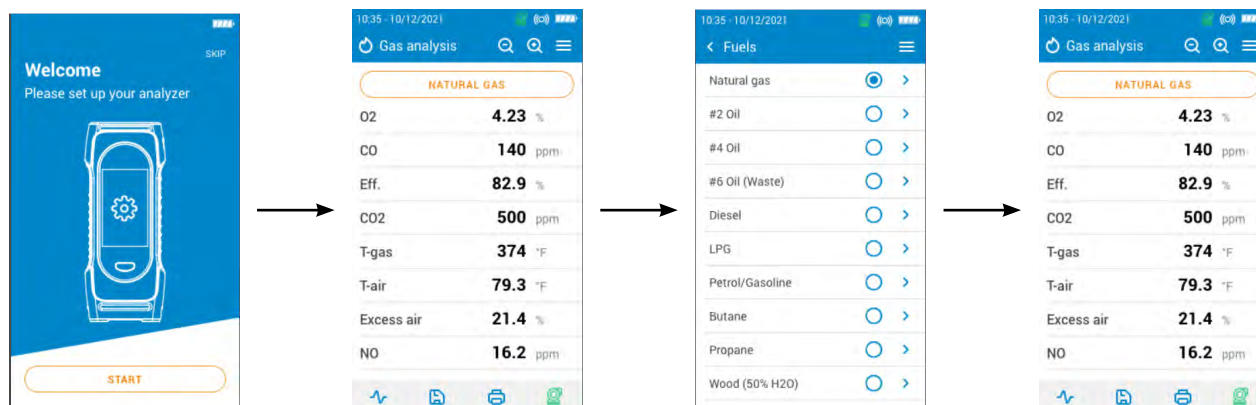
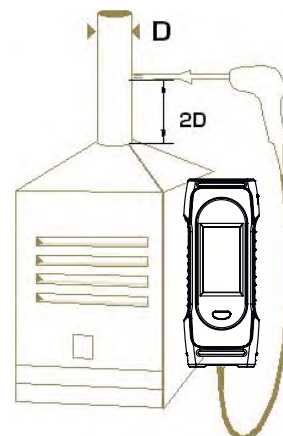

### 5.3 Turn ON and OFF the gas sampling pump

During a gas analysis, it is possible to turn off the gas sampling pump. Calculated and measured values will be then on hold.

During the measurements:

To turn OFF the gas sampling pump:

- Tap  on the bottom right of the screen.
- The pump stops and values are on hold.

To turn ON the gas sampling pump:

- Tap  on the bottom right of the screen.
- The pumps restarts and values are measured.

### 5.4 Visualize data as graph

It is possible to visualize the measured data as graph.

During the measurements:

- Tap .
- Tick the boxes to select one or to parameters to display.
- Select the time period to display.
- Tap "Start".

The analyzer displays the measurements as graph.

### 5.5 Save the analysis

During the combustion gas analysis, when measurements are constant, it is possible to save the gas analysis data to a previously created data folder or to a newly created folder.

- Tap .

The analyzer displays the list of recorded folders.

- Select a folder or create a new folder.
- If creating new folder, type in the folder name and then save by tapping on  icon. Then select new folder after it has been created and saved.
- Tap "Save".

The analyser returns to the measurement screen of the analysis after the data point is saved.

### 5.6 Print the analysis results

It is possible to print the results on the ticket with the optional printer accessory.

The printer must be connected via the wireless connection to the analyzer. See page page 26 to connect and set up the printer.

- Tap  during the analysis.

Measured values are printed on the ticket.

## 5.7 Use the Zoom function

From the gas analysis screen, the zoom function is available using . The initial screen displays 8 measured values.

- To zoom in, tap . The screen displays 4 values.

- To zoom in again, tap . The screen displays 2 values.

- To zoom out, tap . The screen displays 4 values.

- To zoom out again, tap . The screen displays 8 values.

- To zoom out again, tap . The screen displays 12 values.



NATURAL GAS	
O2	4.23 %
CO	140 ppm
Eff.	82.9 %
CO2	500 ppm
T-gas	374 °F
T-air	79.3 °F
Excess air	21.4 %
NO	16.2 ppm



NATURAL GAS	
O2	4.23 %
CO	140 ppm
Eff.	82.9 %
CO2	500 ppm



NATURAL GAS	
NO2 L(O2)	54 ppm
CO	140 ppm



NATURAL GAS	
O2	4.23 %
CO	140 ppm
Eff.	82.9 %
CO2	500 ppm



NATURAL GAS	
O2	4.23 %
CO	140 ppm
Eff.	82.9 %
CO2	500 ppm
T-gas	374 °F
T-air	79.3 °F
Excess air	21.4 %
NO	16.2 ppm
NO	16.2 ppm
NO	16.2 ppm
NO	16.2 ppm

NATURAL GAS	
O2	4.23 %
CO	140 ppm
Eff.	82.9 %
CO2	500 ppm
T-gas	374 °F
T-air	79.3 °F
Excess air	21.4 %
NO	16.2 ppm

## 6. Set the general parameters of the analyzer

The settings menu allows to set the general parameters of the analyzer:

- Time
- Time zone
- Date
- Language
- Country
- Wireless connection
- Autozero
- Purge time
- Brightness



Any changes made to settings are automatically saved when you exit the screen.

### 6.1 Set the time

“Settings > General” screen is displayed.

- Tap “Time”.
- Set the time and select the hour format (24 hours and AM or PM).

### 6.2 Set the time zone

“Settings > General” screen is displayed.

- Tap “Time Zone”.
- Set the time zone.

### 6.3 Set the date

“Settings > General” screen is displayed.

- Tap “Date”.
- Set the date and the date format (Month-Day-Year or Day-Month-Year)

### 6.4 Set the language

“Settings > General” screen is displayed.

- Tap “Language”.
- Select the language among English, French, Spanish, Italian, German, Portuguese and Chinese.

### 6.5 Set the country

“Settings > General” screen is displayed.

- Tap “Country”.
- Select the country from available list. If desired country is not on list, then select area of the world (EMEA, AMERICAS, APAC) show at the bottom of the country list.

### 6.6 Set the autozero

This part allows to set the autozero duration.

“Settings > General” screen is displayed.

- Tap “Autozero”.
- Select the autozero duration: 30 s, 60 s, 120 s or 180 s (default value is 60 s).



The manufacturer recommendation is a minimum of 60 seconds for most applications.

### 6.7 Set the purge time

This part allows to set the purge time duration.

“Settings > General” screen is displayed.

- Tap “Purge time”.
- Select the purge time: 15 s, 30 s, 60 s or 120 s.



## 6.8 Set the self-extinction

It is possible to activate a self-extinction on the analyzer: it will turn off after a certain period of time of non-use.

From main menu:

- Tap **"Settings"**.
- Tap **"General"**.
- Tap **"Self extinction"**.
- Activate the self extinction on top of the screen.
- Select the period of time: 1 hour or 2 hours.



Before turning off, the analyzer will make a purge.

## 6.9 Set the brightness of the screen

**"Settings > General"** screen is displayed.

- Tap **"Brightness"**.
- Set the brightness level from 1 to 5.

## 6.10 Reset to factory setting

It is possible to set the analyser with its factory setting.

From main menu:

- Tap **"Settings"**.
- Tap **"General"**.
- Tap **"Factory settings"**.
- Tap **"Reset and restart"**.



**The analyzer will be reset to original delivery settings. All your configurations will be deleted.**

Units and values of measurement settings of the factory setting:

- Purge time: 30 s
- Autozero: 60 s
- Stack cross sectional area: 10 cm<sup>2</sup>
- Saving interval: 10 s
- Saving duration: 5 s
- Reference O<sub>2</sub>: 20.9%
- NOx factor: 1.05
- Atmospheric pressure: 1013.25 mbar
- Air temperature: 21.5 °C
- K value: 0.84
- Smoke soot: 2
- Smoke soot: disable
- CO cut-off threshold: 2000 ppm
- CO cut-off: enable
- Pump after autozero: deactivated

## 7. Set the parameters of the analysis

This menu allows to set the following items regarding the analysis:

• Fuel	• Pump after autozero
• CO pump cut-off level	• Zero draft sensor
• Reference O <sub>2</sub>	• Atmospheric pressure
• NOx factor	• Air temperature
• Smoke/soot	• Display configuration
• Alarms	• Stack cross-sectional area

### 7.1 Set the fuel

This part allows to select the required fuels for the gas analysis but it also allows to add customized fuels.

#### 7.1.1 Select the fuel

The default list of fuels is dependent on the country selected. Possible fuels listed include the following:

• Natural Gas (H)	• Biogas
• Natural Gas (L) Groningue	• Firewood 20% (Soft)
• Natural Gas North America	• Firewood 50% (Soft)
• #2 Oil / Domestic	• Firewood 20% (Hard)
• #3 Oil / Heavy	• Firewood 50% (Hard)
• #6 Oil / RFO	• Wood Chips / Pellets 8%
• Propane	• Cannel Coal
• Butane	• Low Volatile Coal
• LPG	• Hog Fuel
• Biofuel 5%	• Peat
• Diesel	• Biomass
• Coke Gas	

"Settings > Analysis" screen is displayed.

- Tap "Fuel".
- Select the required fuel.

 To see features of the fuel, tap on it. The following information about the fuel is displayed: A1, B, K, CO<sub>2</sub>t(%), V dry gas (m<sup>3</sup>/ucb), M air (kg/ucb), MH<sub>2</sub>O (kg/ucb) and PCI (MJ/ucb)

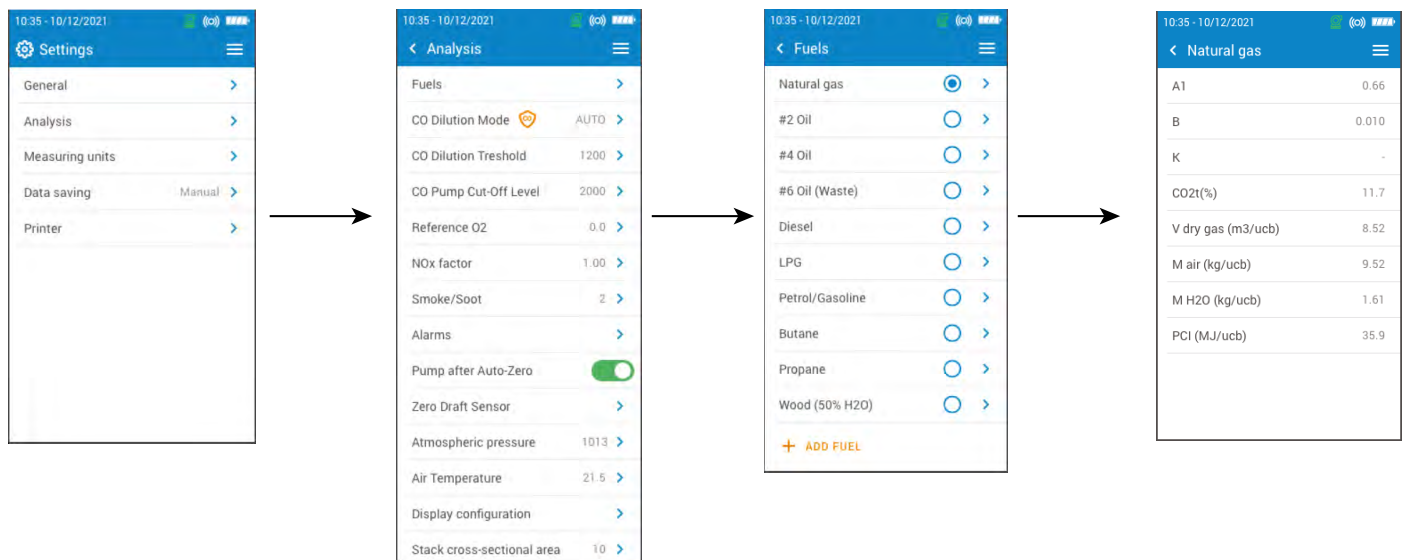

## 7.1.2 Create a fuel

It is possible to create a customized fuel.

"Settings > Analysis" screen is displayed.

- Tap "Fuel".
- Tap "Add fuel" on the bottom of the screen.
- Name the fuel and validate it tapping 
- Enter the following features of the fuel: A1, B, K, CO<sub>2</sub>t(%), V dry gas (m<sup>3</sup>/ucb), M air (kg/ucb), MH<sub>2</sub>O (kg/ucb) and PCI (MJ/ucb).
- Tap "Save".

The customized fuel is then integrated at the end of the fuel list.



If a very specific fuel must be created please contact the Sauermann Service Center for further information.

A customized fuel can be deleted:

- Tap the name of the customized fuel on the fuel list.

Features of this fuel are displayed.

- Tap  on the top of the screen.

A message is displayed asking to confirm the deleting.

- Tap Yes to confirm.

## 7.2 Set the CO pump cut-off level

This part allows to define the CO pump cut-off level.

"Settings > Analysis" screen is displayed.

- Tap "CO pump cut-off level".
- Enter the required level between 1000 and 8000 ppm.



To enable the CO pump cut-off level, activate the protection at the top of the screen.

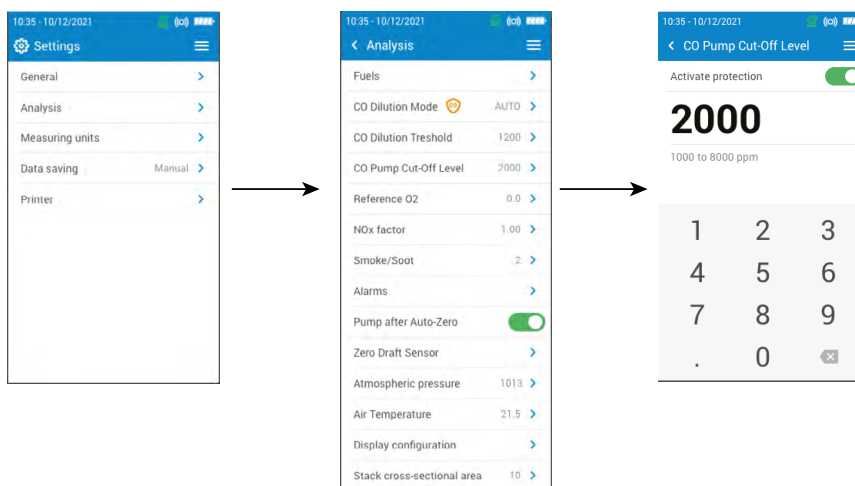

### 7.3 Set the NOx factor

This part allows to set the NOx factor, which is the assumed NO to NO<sub>2</sub> ratio used to calculate NOx when the NO sensor is included but the NO<sub>2</sub> is not included. The same applies when NO and NO<sub>2</sub> are low range sensors.

"Settings > Analysis" screen is displayed.

- Tap "NOx factor".
- Enter the required NOx factor in percentage between 1.00 and 1.50.

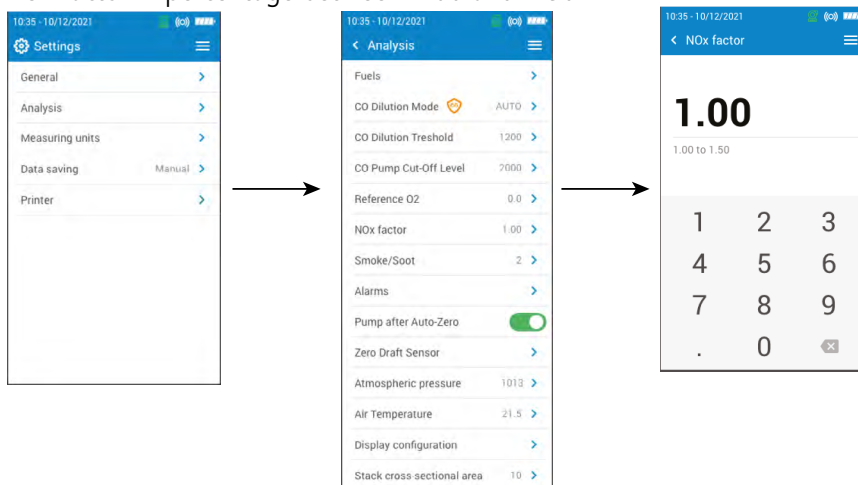

### 7.4 Set the Smoke/soot index

This part allows to enter the smoke or soot index obtained with an external pump (available as option). An input smoke value will be included with saved data points.

"Settings > Analysis" screen is displayed.

- Tap "Smoke/soot".
- First activate the function at the top of the screen to enable the smoke value to be entered.
- Enter the smoke/soot index between 0 and 9.

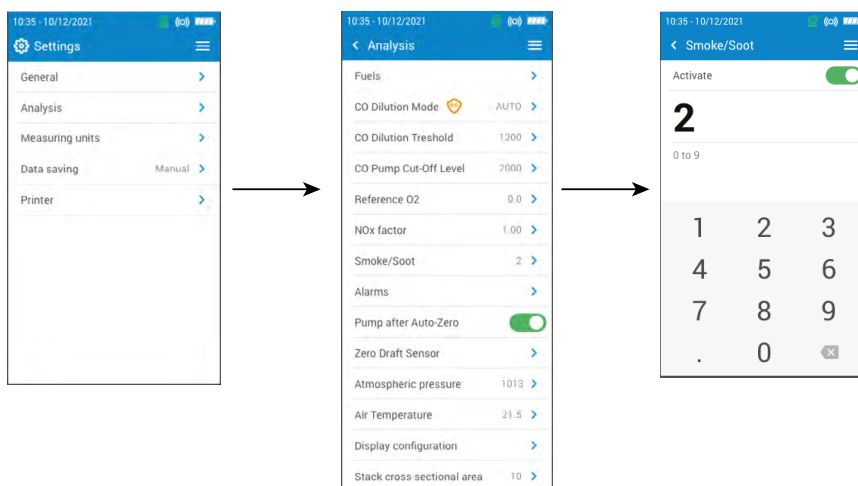

### 7.5 Set the alarms

This part allows to set an alarm for parameters measured and calculated by the analyzer.

This alarm can be rising (the alarm of the instrument is activated when the measured value exceeds the defined threshold) or falling (the alarm of the instrument is activated when the measured value is below the defined threshold).

A maximum of 5 different alarms can be set.

"Settings > Analysis" screen is displayed.

- Tap "Alarms".
- Tap on one of the five listed alarms to first set it up.
- Select the parameter in which the alarm will be activated on the "Parameter" line.
- Enter the threshold value on the "Value" line.
- Select either high threshold or low threshold alarm.

- Return to main Alarm screen and tap on the activate button in order for the alarm to be enabled.
- Repeat the procedure for other alarms as needed.



Alarms can be revised later (for example, different threshold value) if needed.

During the measurements, an alarm remains ON even if the measurement goes below or above the threshold value until it is acknowledged.

If the alarm is acknowledged and the value is always in alarm, the alarm remains ON.

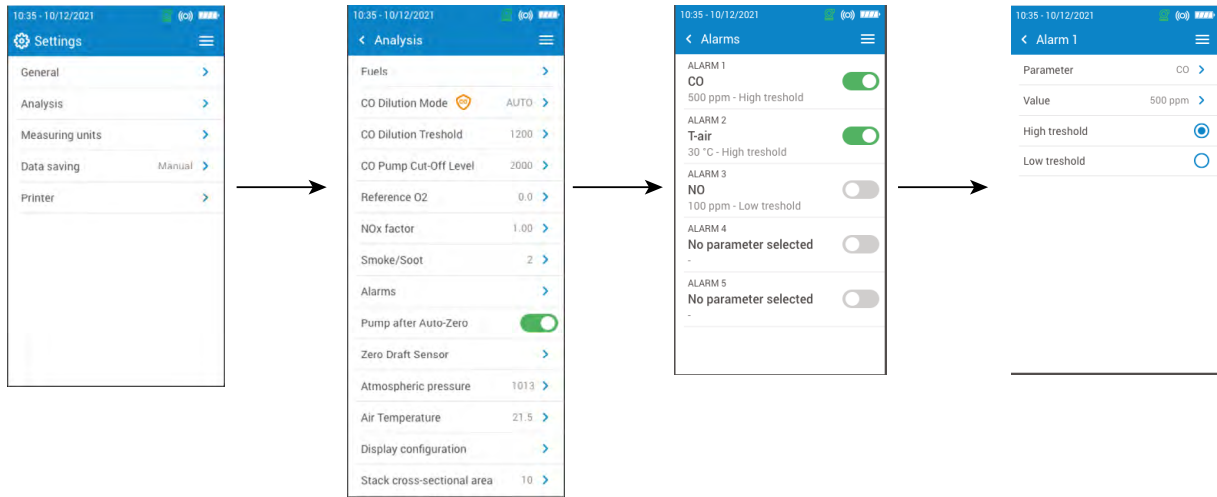

## 7.6 Zero draft sensor

This part allows to reset the draft sensor and the high accuracy sensor (if this optional sensor is installed on the analyzer)..  
**"Settings > Analysis"** screen is displayed.

- Tap **"Zero Draft Sensor"**.
- Remove the smoke probe from the stack and leave the analyzer pressure connectors free of use.
- Tap **"Start"**.

The draft sensor is re-zeroed (takes a few seconds to complete).

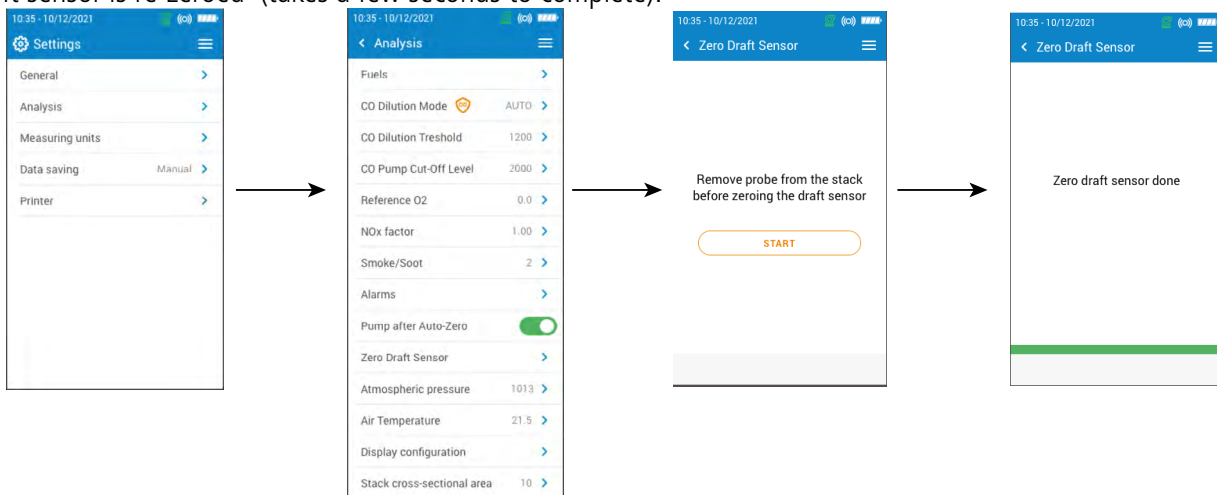

## 7.7 Set the atmospheric pressure

This part allows to set the atmospheric pressure in which measurements are performed. This value is taken into account in calculations such as the smoke velocity. It is set to 1013 mbar by default.

"Settings > Analysis" screen is displayed.

- Tap "Atmospheric pressure".
- Set the atmospheric pressure between 500 and 1100 mbar.

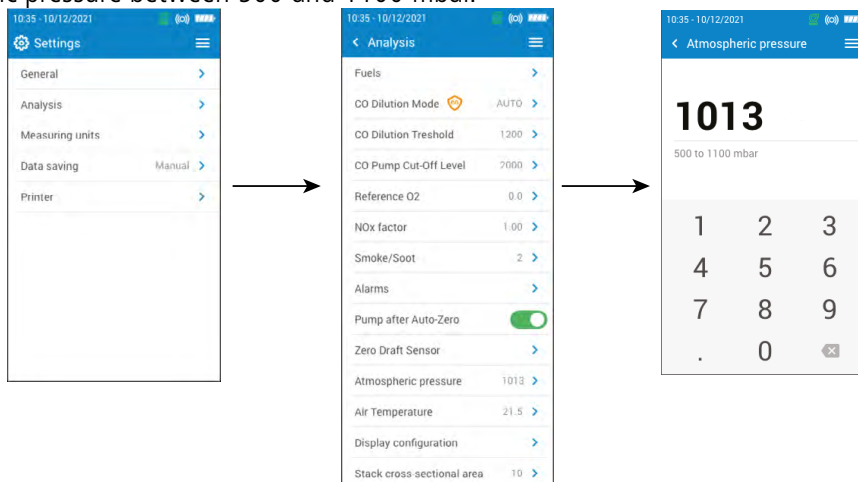

## 7.8 Set the air temperature

This part allows to set the air temperature for the incoming air into the combustion equipment if known. This value is obtained by three different ways:

- by an external probe if this optional probe is connected
- entered by the user if no probe is connected
- by the internal NTC sensor of the analyzer if no probe is connected and if no value entered

To enter an air temperature:

"Settings > Analysis" screen is displayed.

- Tap "Air temperature".
- Activate it at the top of the screen.
- Enter the required air temperature.

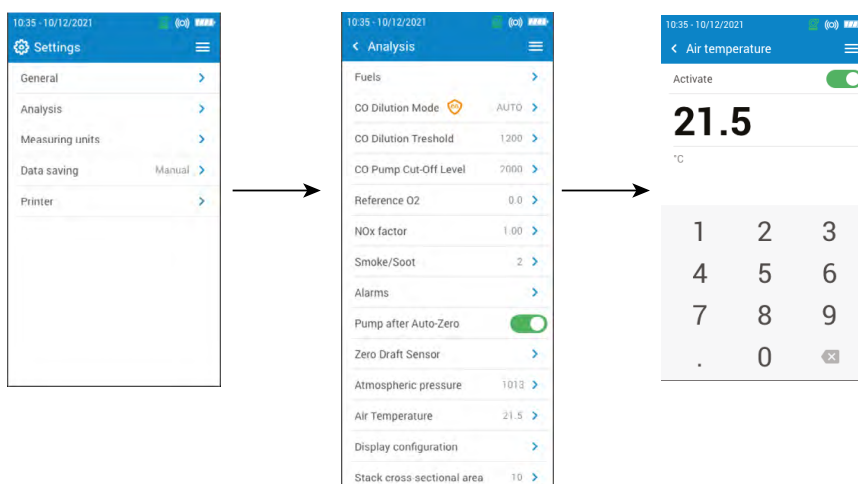

## 7.9 Set the display configuration

This section is used to organize the display of values on the gas analysis screen.

"Settings > Analysis" screen is displayed.

- Tap "Display configuration".
- Tick the parameter boxes for the parameters that are to be shown on the gas analysis screen.
- Use up and down arrows to move values up or down on the gas analysis screen to put the parameters in the desired sequential order.

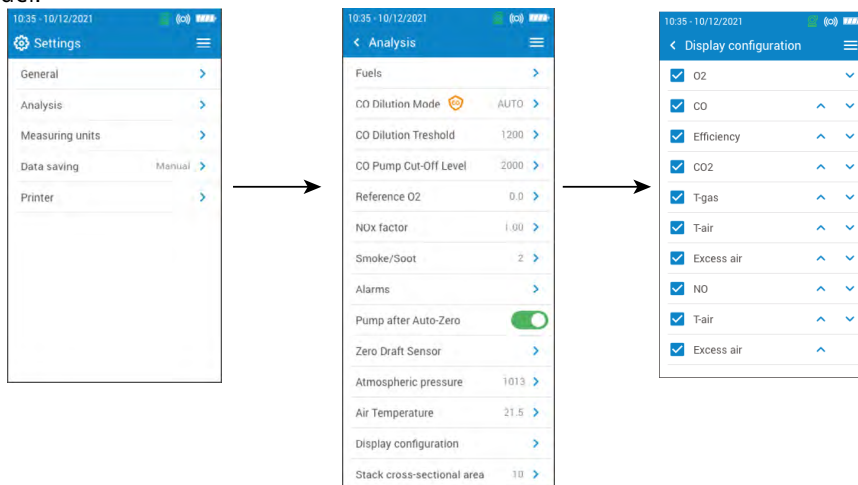

## 7.10 Set the stack cross-sectional area

This part allows to define surface of the stack cross-sectional area that will help to measure the stack gas velocity.

"Settings > Analysis" screen is displayed.

- Tap "Stack cross-sectional area".
- Enter the surface between 0 and 99,999 cm<sup>2</sup>.

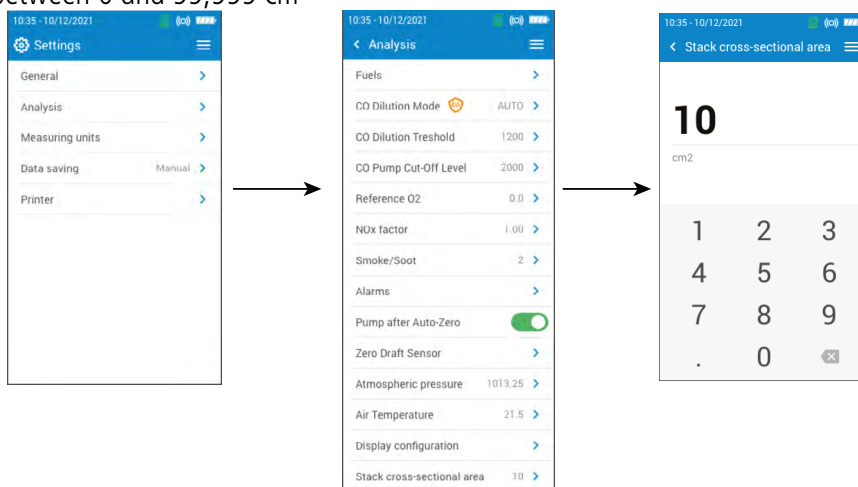

## 8. Set the measuring unit

This part allows to define the measuring unit for each parameters measured or calculated by the analyzer.

The following unit is available according to the parameter:

- Temperature: °C, °F
- Pressure: mbar, iwg (inches water gauge), mmwg, mmHg, Pa, hPa, kPa, psi
- Gas concentrations: ppm, mg/m<sup>3</sup>, %, mg/kWh, g/GJ, g/m<sup>3</sup>, g/kWh, g/hp
- Excess air: %, --- (no unit)
- Stack gas velocity: m/s, f/m, km/h, mph
- Volumetric flow rate: m<sup>3</sup>/m, cf/m
- Mass flow rate: kg/h, lb/h, t/d
- Stack cross-sectional area: cm<sup>2</sup>, in<sup>2</sup>

“Settings” screen is displayed.

- Tap “Measuring units”.
- Tap the required parameter to set.
- Select the required unit in the list.

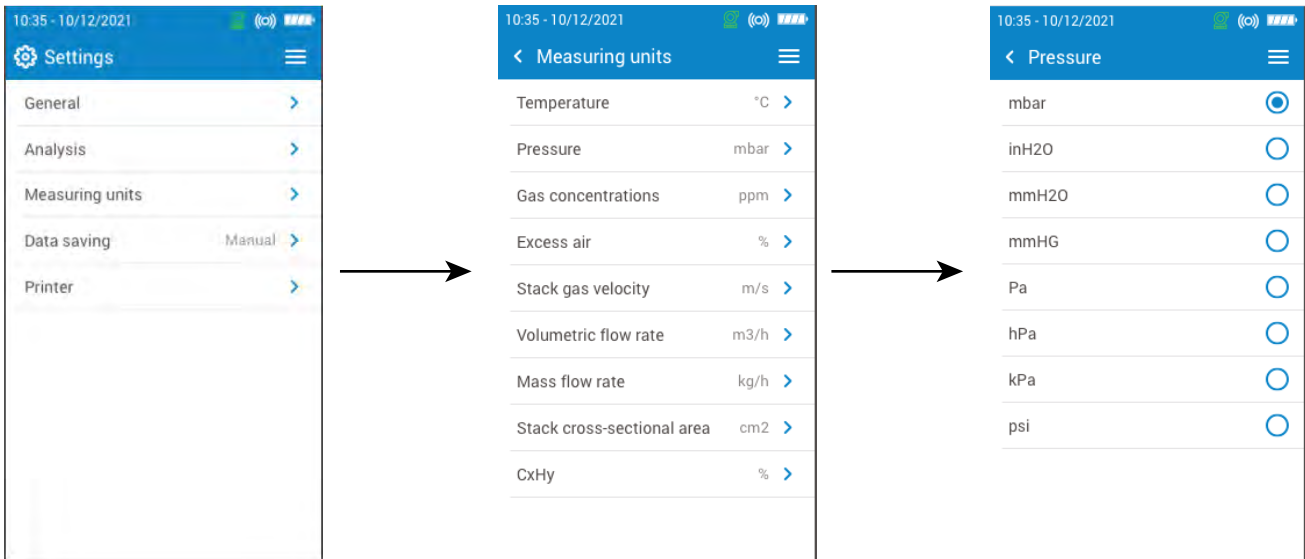



## 9. Set the data saving

This part allows to define the data saving mode: manual or data logger

"Settings" screen is displayed.

- Tap "Data saving".
- Select "Manual": data will be manually saved during measurement.  
or
- Select "Data logger": data will be saved according to a specified time interval and duration.
- Define the time interval between 10 and 600 seconds (by default time interval 10 seconds and duration 10 min).  
This time interval is for how often data points will be saved and to respect a maximum of 60 points per campaign.
- Tap "Next".
- Define the duration between 1 and 120 minutes. The duration is the total time for the entire test period.
- Tap OK.



Data will not be saved until initiated on the gas analysis screen (see chapter "It is possible to visualize the measured data as graph." on page 14)  
Only displayed values are saved.



When combustion analysis is on hold, saving and printing data are possible.

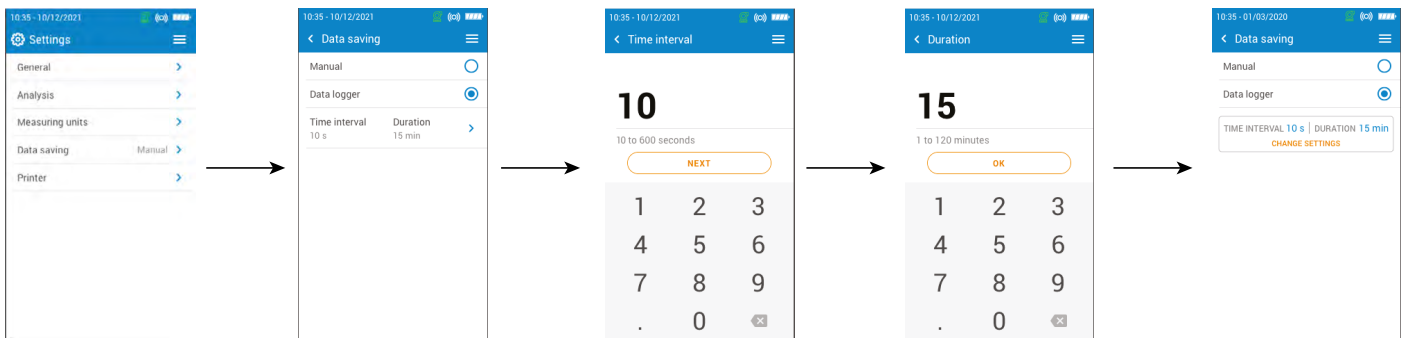

The following screen will be displayed if the memory is insufficient:

- Tap "Change setting".
- Modify the time interval or the duration.

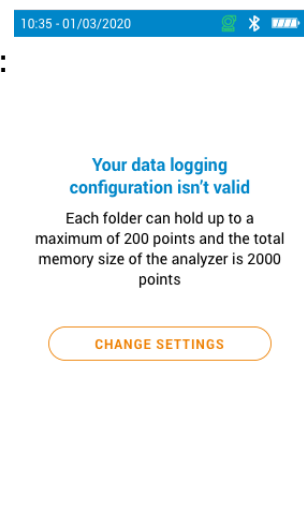

## 10. Set the printer

This part allows to set the printer specifications: printer connection, custom header and number of copies.

This printer is available as option.

### 10.1 Set the printer connection

"Settings > Printer" screen is displayed.

- Turn on your wireless printer.
- Tap "**Printer connection**".
- Activate the "**Wireless printer mode**" button.
- Tap "**Search for printers**".

The analyzer searches for available printers and then displays the results.

- Tap the required printer.



The analyzer can not be connected to the app and the printer at the same time. If the analyzer is connected to the app, disconnect it from the app and then search again for printers.

### 10.2 Custom the printing header



Tap  or  to change capital letters and numbers to/from lower case letters and symbols.

It is possible to customize the header of the ticket with you own contact details.

"Settings > Printer" screen is displayed.

- Tap "**Custom header**".
- Enter your own information.
- Tap the validate sign  at the bottom right of the screen.

### 10.3 Set the number of copies

It is possible to set the number of copies that will be printed (default number is 1).

"Settings > Printer" screen is displayed.

- Tap "**Number of copies**".
- Use up and down arrows to define the number of copies. Maximum number of copies is five.

# 11. Analyzer information

This part gives information about the analyzer:

- Service and Calibration
- Gas sensor information
- Model number
- Serial number
- Firmware version
- Battery status
- Memory status (how much memory is available)

From the main menu of the analyzer:

- Tap **"Analyzer information"**.

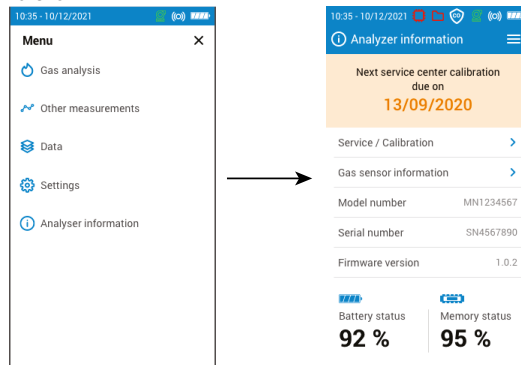

## 11.1 Service and Calibration

### 11.1.1 Calibration information

This screen gives calibration information about gas sensors installed into the analyzer.

**"Service / Calibration"** screen is displayed.

- Tap **"Calibration Information"**.

The following information is displayed for each installed gas sensor that can be selected:

- Date of Last service center calibration
- Date of last user calibration
- Due date of next service center calibration
- Tap **"Contact Service Center"** at the bottom of the screen, the address where the analyzer should be sent is displayed.

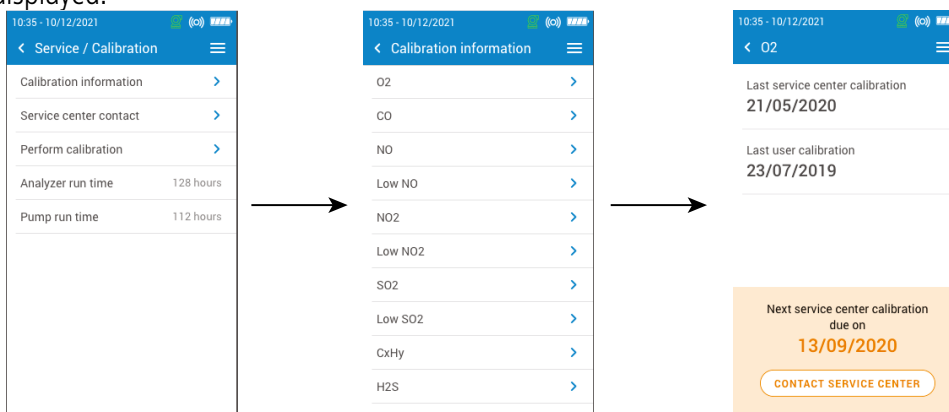

### 11.1.2 Service center contact

**"Service / Calibration"** screen is displayed.

- Tap **"Service Center Contact"** to display the address of the Sauer mann Service Center.

### 11.1.3 Perform calibration

This screen allows the user to perform a calibration on a gas sensor.



**The calibration must be performed by a qualified technician.**



All modifications performed in this menu will affect the measurement values. If false manipulations are done, measurement values will be wrong.

“Service / Calibration” screen is displayed.

- Tap “Perform Calibration”.
- Enter the code to access to calibration.



To get your code, please contact the Service Contact. Our team will explain how to get this code.

- Tap “Access Calibration”.
- Select the gas sensor on which the calibration must be applied.
- Enter the new reference value then tap Start.

The analyzer performs the measurement for a defined time and displays the following information:

- Measurement
- Sensor current
- Reference value
- During the measurement, if values are correct, tap “Validate adjustment” on the bottom of the screen.
- Tap “Save adjustment” to apply the calibration on the gas sensor.
- Tap “Restart analyzer” for changes to be taken into account.

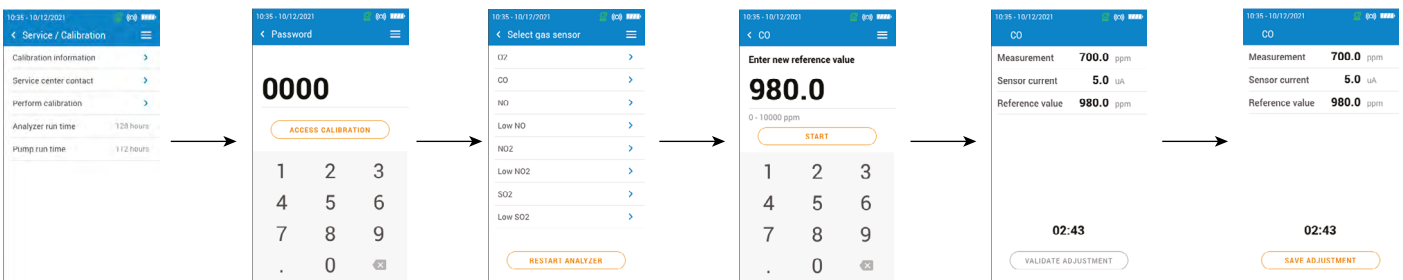

## 11.2 Gas sensor information

This screen gives information about the gas sensor installed on the analyzer.

“Analyzer information” screen is displayed.

- Tap “Gas sensor information”.
- Tap the gas sensor on which information must be displayed.

The following information is displayed:

- Type of sensor
- Serial number of the sensor
- Measuring range of sensor
- Date of last calibration
- Date of installation
- Output current (in units of micro amps)
- Sensor life estimation: a four bar display is shown. When down to one bar, it is recommended to contact an authorized Sauer mann service center

## 11.3 Other information

Analyzer information screen also gives the following information:

- Model number / Serial number
- Firmware version
- Battery status
- Memory status



Please provide the model number and serial number for contact with the manufacturer or the Service Center.

## 12. Perform other measurements

The analyzer can perform other measurements than a gas analysis:

- CO monitor
- Gas tightness test
- Gas/pump flow rate
- Heat exchanger integrity test
- Stack gas velocity
- Draft

### 12.1 Perform CO monitoring

The CO monitoring is performed with the external CO probe (available as option) or with the internal CO sensor.

- Connect a CO probe (available as option) on the DIN connection on the bottom of the analyzer (if the CO probe is used).
- Turn on the analyzer.
- Tap **"Menu"** then **"Other Measurements"**.
- Tap **"CO monitor"**.

The measurement is launched, the instrument displays the current level of CO, the maximum level of CO, and the duration of the test. The maximum CO level and duration are reset each time the CO Monitor screen is entered.



If the internal sensor is used, the main pump will be ON and if the CO probe is used the main pump will be OFF.

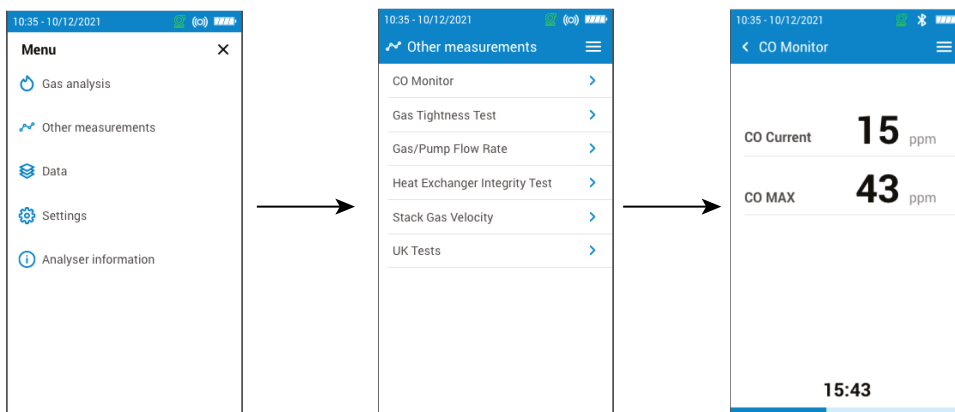

### 12.2 Perform a gas tightness test

To perform this test, it is necessary to have a Differential pressure hose kit. This kit is available as option (ref: KEG3).

#### 12.2.1 Perform a gas tightness test according to UNI 7129 (new piping)

- Connect the hose to the gas analyzer P+.
- Connect the hose to the piping system.
- Select the piping system: UNI 7129 (new piping)
- Select the estimated volume: < 100 dm<sup>3</sup>, 100-250 dm<sup>3</sup> or 250-500 dm<sup>3</sup>.
- Select the fuel: natural gas or LPG
- Pressure the pipe up to 150.00 hPa.
- Tap **"Start stabilization"**.

The analyzer starts the stabilization which takes 15 minutes.

At the end of the stabilization, the analyzer starts the test and then displays the following results:

- P1
- P2
- Pressure drop
- Pressure drop allowed

According to the results, the analyzer will display if the test is compliant or not compliant.

#### 12.2.2 Perform a gas tightness test according to UNI 11137 (existing piping)

- Connect the hose to the gas analyzer P+.
- Select the piping system: UNI 11137 (existing piping)

- Select the test type: Preliminary test (< 18 dm<sup>3</sup>) or Indirect test (>18 dm<sup>3</sup> up to 35 dm<sup>3</sup>)

If Preliminary test is selected:

- Select the fuel: natural gas or LPG.
- Read the gas pressure inside the pipe.
- Tap "**Start stabilization**".

The analyzer starts the stabilization.

- Tap "**Start test**" once the stabilization is completed.

At the end of the test, the analyzer displays the following results:

- P1
- P2
- Pressure drop
- Pressure drop allowed

According to the results, the analyzer will display if the test is compliant or not compliant.

If Indirect test is selected:

- Select the fuel: natural gas or LPG.
- Select the test gas: fuel or air.

**If the volume is known:**

- Enter the known volume of the installation between 19 and 999 dm<sup>3</sup>.
- Connect the hose to the piping system.
- For test with gas, read the gas pressure inside the pipe.
- For test with air, pressure the pipe up to 22 hPa for natural gas pipeline or 30 hPa for LPG pipeline.
- Tap "**Start stabilization**".

The analyzer starts the stabilization.

- Tap "**Start test**" once the stabilization is completed.

At the end of the test, the analyzer displays the following results:

- P1
- P2
- Pressure drop
- Leakage rate
- Maximum leak allowed

According to the results, the analyzer will display if the test is compliant or not compliant.

**If the volume is unknown:**

- Connect the hose to the piping system.
- For test with gas, read the gas pressure inside the pipe.
- For test with air, pressure the pipe up to 22 hPa for natural gas pipeline or 30 hPa for LPG pipeline.
- Tap "**Start stabilization**".

The analyzer starts the stabilization.

- At the end of the stabilization, extract a volume from pipeline using the Syringe (20 or 100 ml).
- Select the volume extracted (20 or 100).
- Wait for the pressure stabilization (minimum 1 min) before tapping "**Refill done**".
- The volume measurement is shown.
- Tap "**Start test**".

At the end of the test, the analyzer displays the following results:

- P1
- P2
- Pressure drop
- Leakage rate
- Maximum leak allowed

According to the results, the analyzer will display if the test is compliant or not compliant.

### 12.3 Gas pump flow rate

This screen shows the real-time measured flow rate of the gas passing through the analyzer as performed by the main flue gas sampling pump.



**The pump of the analyzer must be turn on.**

“Other measurements” screen is displayed.

- Tap “Gas/pump Flow Rate”.

The analyzer displays the flow rate of the pump in L/m.

### 12.4 Heat exchanger integrity test

This test provides information to help determine if there might be a crack or leak in the heat exchanger and/or combustion chamber.



**The pump of the analyzer must be on to perform this test.**

“Other measurements” screen is displayed.

- Tap “Heat Exchanger Integrity Test”.
- Insert the sampling probe into the exhaust flue/pipe.
- Turn on the heating equipment (with the blower off) and let the O<sub>2</sub> & CO measurements stabilize on the analyzer screen.
- Tap Start icon  on the bottom of the screen to start the Heat Exchanger Integrity Test on the analyzer right before the blower turns on. Make sure the blower turns on during the first 30 seconds of the test period.

The results of the test will calculate the amount the O<sub>2</sub> and CO measurements varied during the 60 second test period. The greater the variances, the more likely there is to be a crack or abnormality with the heating system that should be investigated by a heating professional.

### 12.5 Perform a Stack Gas Velocity measurement with a Pitot tube



**To perform this test, it is necessary to have a Pitot tube Type L or Type S.**

#### Place and connect the L Pitot tube:

The Pitot tube must be introduced perpendicularly, in the middle into the duct and parallel to the flow.

The head (ending with an ellipsoidal nose) must be maintained parallel and facing the flow.

The total pressure (+) caught by the nose, is connected to the P+ at the bottom of the analyzer.

The static pressure (-) caught by the holes of the head, is connected to the P- at the bottom of the analyzer.

#### Place and connect the S Pitot tube:

The S-type Pitot tube is inserted into the stack and rotated until the differential pressure measurement is greatest for a given location in the stack. The proper orientation is for the high pressure side of the S-type Pitot tube tip to face into the direction of the stack gas flow as shown in the diagram.

The holes must be perfectly aligned with the air or gas flow direction.

The Pitot tube S is more sensitive to alignment errors than the Pitot tube L.

The connecting to the measurement device must be carried out like following:

- The leg in front of the air flow is connected to the P+ sign of the analyzer.
- The leg at the opposite of the air flow is connected to the P– sign of the analyzer

When the connections are made and “Other measurements” screen is displayed :

- Tap “Stack Gas Velocity”.

The analyzer displays the following measurements: Velocity, Volume flow and Mass Flow.

- Tap the K value to modify it if necessary (K value must be between 0.0000 and 99.0000).



Recommended values are: 0.84 for S-Type Pitot tube and 1.0015 for L-Type Pitot tube.

- For proper calculations of volumetric flow rate and mass flow rate, enter correct stack cross-sectional (see chapter "7.13 Set the stack cross-sectional area" on page 23)

## 12.6 Perform a draft measurement

The analyzer can measure the draft. This draft can be measured by the flue gas probe or the draft probe.

- Tap **"Menu"** then **"Other Measurements"**.
- Tap **"Draft"**.

Screen for the draft measurements contains 3 lines:

- Outside Air Temperature: ambient temperature manually entered. Default value: 15 °C / 59 °F
- Draft: draft/pressure measured by internal pressure sensor
- Normalized draft: calculated value of the draft at a temperature of 20 °C / 68 °F

The outside air temperature can be manually changed. This value must be between -25 and +19.9 °C (-13 and 66.2 °F).

Change the outside air temperature from the **"Draft"** screen:

- Tap the blue arrow on the **"Outside air temperature"** line.
- Enter the required outside air temperature between -25 and +19.9 °C (-13 and 66.2 °F).
- Tap **"Outside Air Temp."** on the top left of the screen to back to the draft measurement screen.

### 12.6.1 Perform a draft measurement with the flue gas probe

- Disconnect the water trap connector from the gas connection of the analyzer.
- Plug the water trap connector with the blue cap.

The analyzer displays the draft without the influence of the main pump.

### 12.6.2 Perform a draft measurement with the draft probe

The draft measurement can be performed thanks to the draft probe available as option.



**If the draft probe is used, it will be necessary to drill another hole dedicated to this draft measurement in the duct.**

- Disconnect the P+ connector of the flue gas probe from the analyzer.
- Connect this connector to the blocked connection of the draft probe.
- Connect the orange connector of the draft probe to the P+ connection of the analyzer.
- Insert the draft probe into the duct.

## 12.7 Perform a measurement of smoke/opacity

It is possible to enter in the analyzer from 1 to 3 smoke/opacity indexes performed thanks to smoke/opacity pump available as option.

The smoke/opacity index consists of the measurement of solid waste of combustion in the flue with a pump and a filter of measurement. The filter coloration is compared with a table reference composed by 10 greyed areas numbered from 0 to 9.

### 12.7.1 Perform the measurement



**Preliminary operation: to avoid the condensation in the pump, it is necessary to breathe in WITHOUT FILTER fresh air before performing a measurement**

- Put the paper filter in the pump.
- Insert tip of pump into the flue/stack.

The necessary gas volume for a measurement of opacity corresponds to about 10 pump strokes.

- Compare the filter clogging to the reference table to determine the opacity index.
- Make the same operation several times if necessary, replace the filter each time.

## 12.8 UK test

The UK test menu allows to access to different tests to perform according to UK regulations.

The available tests are the following:



- CO Sweep
- Room Safety
- Let By



**For CO Sweep and Room Safety tests, an external CO<sub>2</sub> probe is needed. This probe is available as option. Please Contact Sauermann to get one.**

### 12.8.1 CO sweep

From the main menu of the gas analyzer:

- Tap **"Other measurements"**.
- Tap **"UK Tests"**.
- Tap **"CO Sweep"**.

The test starts and lasts 20 minutes.



The analyzer displays the measured CO and CO<sub>2</sub> in the room. It displays also peaks for these values.

At the end of the test, the analyzer displays the maximum values of measured CO and CO<sub>2</sub>.



**If the CO max is equal or lower than 10 ppm and the CO<sub>2</sub> max is lower than 15,000 ppm, test is OK.**

**If the CO max is higher than 10 ppm and the CO<sub>2</sub> max is higher than 15,000 ppm, test is not OK.**

- Print the results if needed by tapping  at the bottom of the screen.
- Save the results if needed by tapping  at the bottom of the screen.



It is possible to stop the test at any time tapping  at the bottom of the screen.

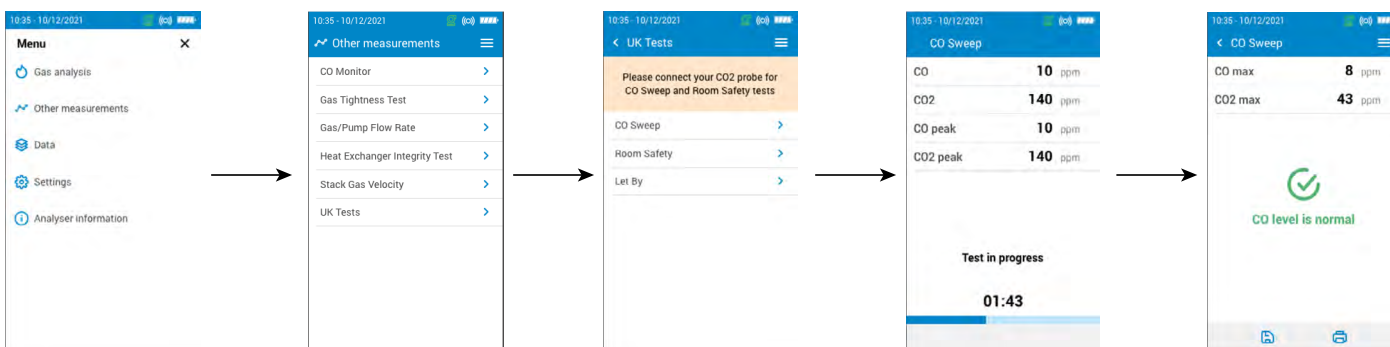

### 12.8.2 Room Safety

From the main menu of the gas analyzer:

- Tap **"Other measurements"**.
- Tap **"UK Tests"**.
- Tap **"Room Safety"**.
- Tap the required appliance in which the measurements must be performed.

The analyzer displays the measured CO and CO<sub>2</sub> in the appliance. It also displays peaks for these values.

At the end of the test duration, the analyzer displays the measured CO max and CO<sub>2</sub> max. According to these values, the CO level is normal or not.

Test durations are according to the appliance selected:

- Boiler: 15 minutes
- Cooker: 20 minutes
- Water heater: 5 minutes
- Space heater: 30 minutes
- Room seal appliance: 15 minutes

CO values above which measurements are not normal:

- Boiler: 10 ppm
- Cooker: 30 ppm
- Water heater: 10 ppm
- Space heater: 10 ppm
- Room seal appliance: 10 ppm

• Print the results if needed by tapping  at the bottom of the screen.

• Save the results if needed by tapping  at the bottom of the screen.



It is possible to stop the test at any time tapping  at the bottom of the screen.

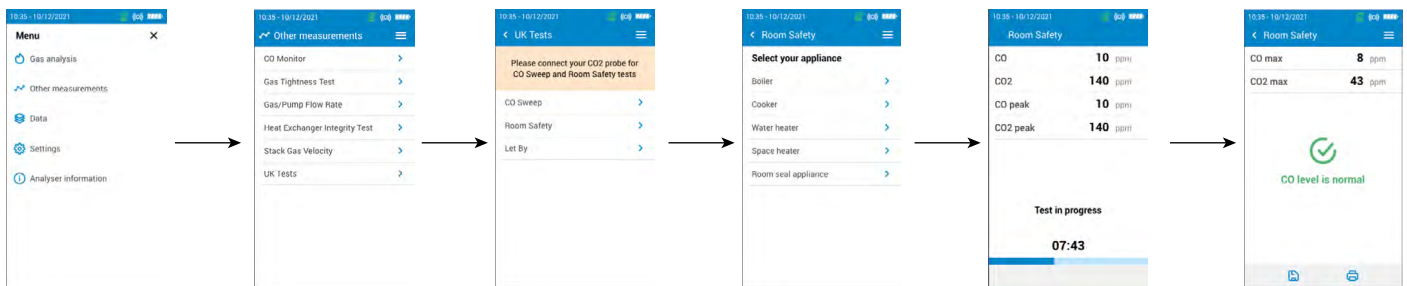

### 12.8.3 Let By

From the main menu of the gas analyzer:

- Tap **“Other measurements”**.
- Tap **“UK Tests”**.
- Tap **“Let By”**.
- Connect the tube to the P+ input of the analyzer
- Tap **“Start pressure autozero”** then **“Start stabilization”**.

The analyzer perform a one-minute stabilization phase and displays the measured pressure.

At the end of the stabilization, the analyzer displays «Stabilization complete».

- Tap **“Validate stabilization”** if the stabilization has been satisfactory

or

- Tap **“Invalidate stabilization”**

If the stabilization is not satisfactory, it's possible to start a new stabilization:

- Tap **“Invalidate stabilization”**.
- Tap **“New stabilization”**.

If the stabilization is validated, the analyzer displays **“Successful stabilization”**.

- Tap **“Start test”**.

The test starts and lasts 2 minutes. The analyzer displays Pressure 1 (P1), Pressure 2 (P2) and the pressure difference (deltaP).

At the end of the test, P1, P2 and deltaP results are displayed and it's possible to validate or invalidate the test according to your specifications.

- Tap **“Validate test”** or **“Invalidate test”**.
- Print the results if needed by tapping  at the bottom of the screen.

- Save the results if needed by tapping  at the bottom of the screen.



It is possible to stop the test at any time tapping  at the bottom of the screen.

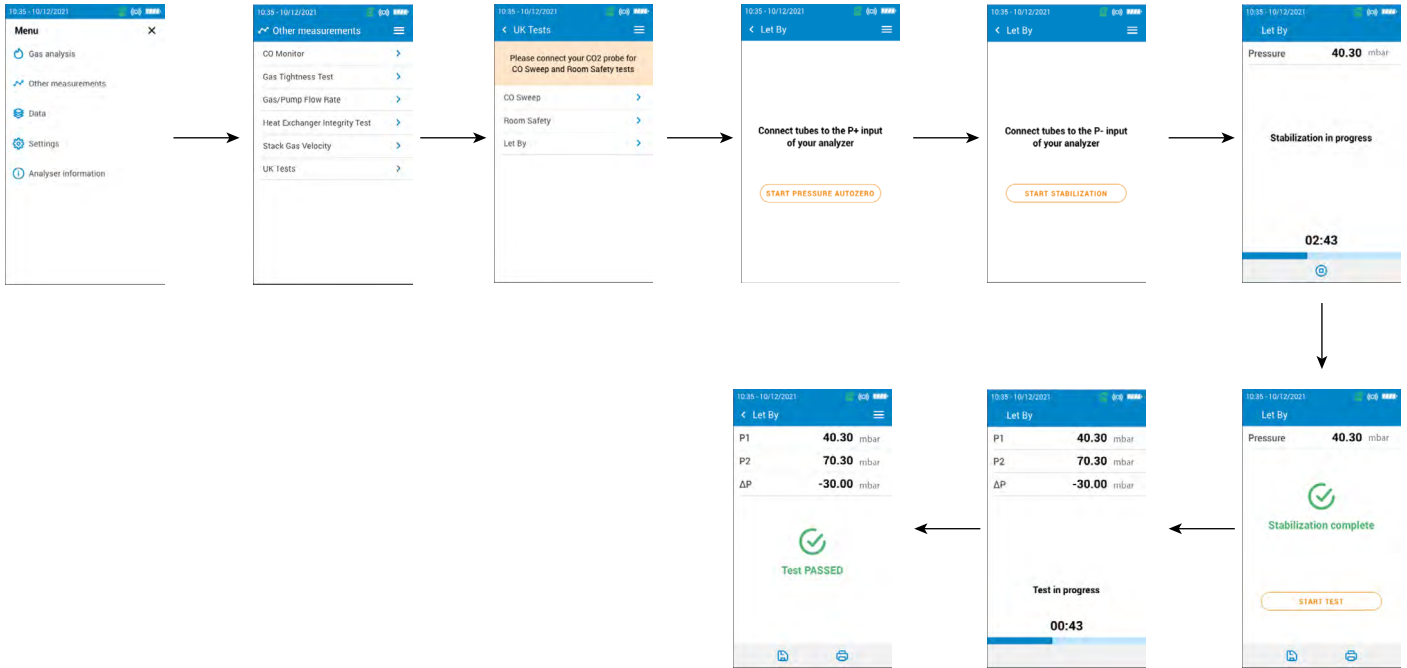

## 13. Maintenance of the analyzer

### 13.1 Life-time of the sensors

Gas sensors are electrochemical type: inside them, in the presence of gas to detect, a chemical reaction occurs that causes an emission of electrical current. The electric current strength detected by the instrument is converted into a corresponding gas concentration. The life-time of the sensor is strongly linked to the reagent consumption present in the sensor. As their consumption increases, features of the sensor are getting worse until their exhaustion, after which it is necessary to replace it. To ensure the measurement accuracy, sensors have to be calibrated only in Assistance center qualified by Sauermann.

Sensor	Average life-time	Required calibration
O <sub>2</sub>	4 to 5 years	Annual
CO	2 to 5 years	Annual
NO	2 to 5 years	Annual
Low NO	2 to 5 years	Annual



**Regularly recharge the battery to guarantee optimal operations of the electrochemical sensors. Do not leave the instrument an empty battery charge. Make sure the battery is always charged even during a long period of non use.**

### 13.2 Replaced used sensor

Follow this procedure to replace a used sensor:

The analyzer must be turned OFF

- Remove the protective rubber holster.
- Turn the analyzer on its back side.
- Open the analyzer by removing 4 screws with cruciform (Philips) screwdriver. The back shell can then be lifted up.
- Disconnect the silicone tubes (1) and (2).
- Pull the black manifold (3) to remove it from the electronic board.
- Pull the sensor to replace from the manifold.
- Do not pull the sensor electronic board.
- Put a new sensor respecting the way of sensor for O<sub>2</sub> and CO sensors as shown on picture 5.
- Put a new sensor respecting the way of sensor for NO sensor as shown on picture 6.
- Replace the black manifold on the Si-CA 130 electronic board making sure to properly align the 10 metal pins (4) into the mating black connector (7).

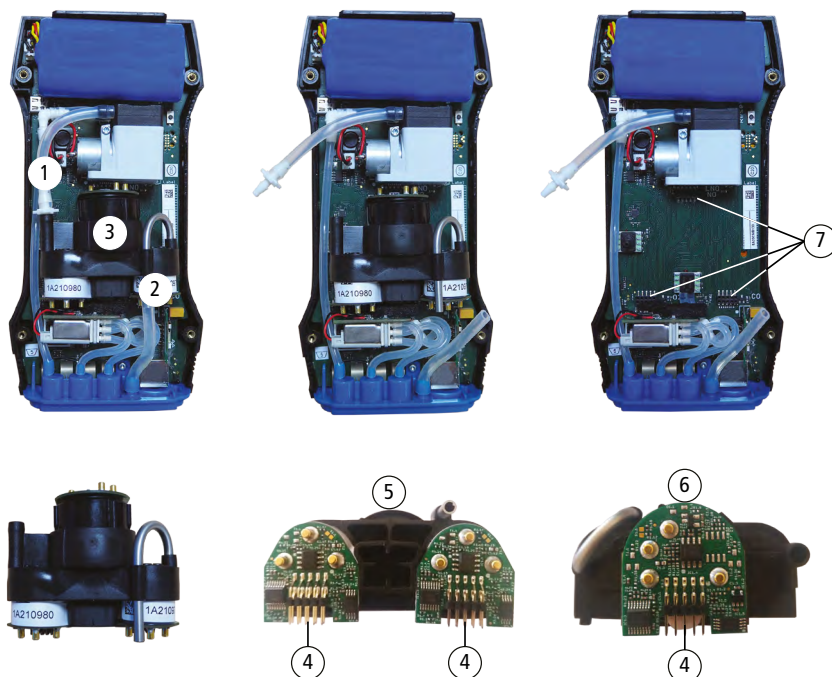



Sensors have very precise locations, see the following locations defined for each sensor:

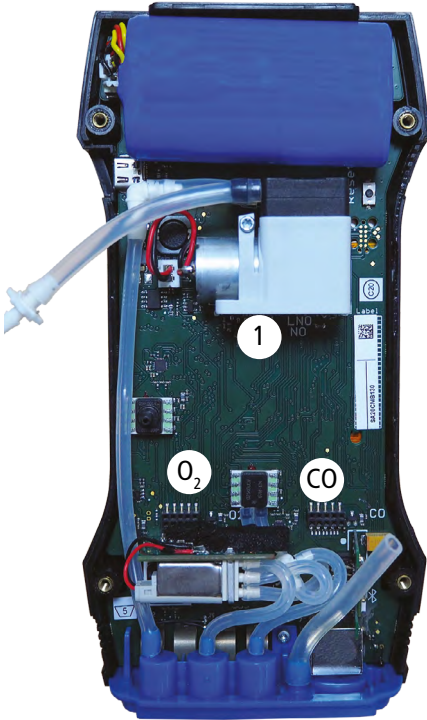

- O<sub>2</sub> sensor must be in O<sub>2</sub> position
- CO-H<sub>2</sub> sensor must be in CO position
- NO or low NO sensor must be in 1 position

When a sensor has been replaced, it is possible to check the proper functioning of this new sensor by going in the "Information" menu of the analyser. It is normal that a sensor that has just been installed gives the following message: "Current Error", it is necessary to wait designated time to stabilize the polarization of the sensor.

Here are the minimum stabilisation times for each sensor:

- O<sub>2</sub>: 1 hour
- CO: 8 hours
- NO: 12 hours
- Low NO: 12 hours

### 13.3 Replace filter inside the water trap

Follow this procedure to replace the filter inside the water trap:

- Disconnect the smoke probe from the analyzer.
- Turn the lower part (2) of the water trap to the left to detach it from the upper part (1).
- Remove the part (3) by pulling it slightly.
- Remove the used filter (4) and replace it by a new one.
- Replace the part (3).
- Turn the lower part (2) of the water trap to the right to fix it on the upper part (1).
- Make sure O-ring is seated properly in the lower part of water trap.



### 13.4 Cleaning the analyzer









Clean the analyzer housing with a damp cloth. Use distilled water.



Do not use isopropanol.

## 14. Optional accessories

The following accessories are available\*:

Part number	Description	Illustration
27520 (NO) 27521 (Low NO)	NO or Low NO sensor for NOx	
27532 (180 mm) 27533 (300 mm) 27534 (750 mm)	180, 300 and 750 mm probes available	
27936	180 mm flexible probe	
27544	Draft probe	
24646	Smart air temperature probe with 2 m cable	
27865	Pt100 temperature probe	
27547	CO ambient probe	
27548	CO <sub>2</sub> ambient probe	
27546	Remote wireless printer	

\*See the Si-CA analyser accessories datasheet for more details.

## 15. Spare parts

The following spare parts are available:

<b>Item number</b>	<b>Description</b>
27705	Rechargeable Battery Pack for Si-CA 130
27709	Analysis chamber for Si-CA 130, With exhaust tube
27710	Upper Shell Assembly for Si-CA 130, With display and normative label
27711	Lower Shell Assembly for Si-CA 130, With magnets
27713	Cell cap for SI-CA 130, to cover third sensor location when not used with gas sensor
27714	Main PCB board for Si-CA 130
27716	Main pump for Si-CA 130
27729	Filter that mounts inside the water trap
27730	O-Ring for Water Trap
27732	Pneumatic Hose Connector for P+ port, with Orange O-Rings
27733	Pneumatic Hose Connector for Gas Inlet, with Black O-Rings
27734	Pneumatic Hose Connector for P- port, with Green O-Rings
27738	Protective Rubber Holster/Boot for Si-CA 030/130
27740	Water Trap with internal filter (without hose/connector)
27741	Water Trap with internal filter, short hose, & gas hose connector
27742	Hose Cap to allow for measuring draft when the analyzer pump is on

**Sauermann Industrie**

ZA Bernard Moulinet  
24700 Montpon  
France  
T. +33 (0)5 53 80 85 00  
services@sauermanngroup.com

**Sauermann NA**

140 Fell Court, Ste. 302  
Hauppauge, New York 11788  
T. (+1) 631-234-7600  
F. (+1) 631-234-7605  
info.usa@sauermanngroup.com

**Sauermann GmbH**

Leibnizstraße 6  
D – 74211 Leingarten  
T. +49 (0)7131/399990  
F. +49 (0)7131/399992  
info.germany@sauermanngroup.com

**Sauermann UK**

Units 7-9, Trident Business Park  
Amy Johnson Way  
Blackpool - FY4 2RP  
T. +44 (0) 870 950 6378  
F. +44 (0) 870 950 6379  
info.uk@sauermanngroup.com

**Sauermann Italia srl SU**

Via Golini 61/10  
40024 Castel S.Pietro Terme (BO)  
T. (+39)-051-6951033  
F. (+39)-051-942254  
info.italy@sauermanngroup.com

**Sauermann Ibérica**

C/Albert Einstein 33.  
Planta 3. P. I. Santa Margarida II-  
08223 Terrassa (Spain)  
T. +34 931 016 975  
info.spain@sauermanngroup.com

**Sauermann Australia**

1/36 Campbell Avenue, Cromer ,2099,  
NSW, Sydney  
T. (+612) 8880 4631  
sauermannpumps.com.au



BE CAREFUL! Material damages can happen, so please apply the precautionary measures indicated.